

CoRx Tester

AUTOMATED COHERENT
RECEIVER TESTER

SPECIFICATION SHEET

Quantifi Photonics' CoRx Tester provides automated measurement of key coherent receiver performance parameters.

The CoRx Tester is comprised of a pre-configured PXI chassis, a two-channel tunable laser, a polarization controller, and a two-channel Variable Optical Attenuator (VOA) with built-in power meter. Just connect the two optical outputs to your Integrated Coherent Receiver (ICR), connect your ICR to the oscilloscope and let the CoRx Tester software do all the rest.

CoRx Tester works with Tektronix's SX series of real-time oscilloscopes which forms the most flexible and versatile Optical Modulation Analyzer (OMA). When paired with an IQRX coherent receiver, the CoRx Tester provides key hardware performance characterization in addition to the OMA signal analysis.

The PXI chassis and modules can also be used for general purpose testing. We offer a wide variety of optical test modules that you can add to your system, making the CoRx Tester a flexible and versatile tool for any environment.

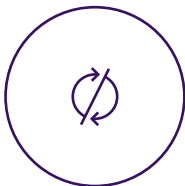

Automated sequential testing.

The laser, VOA and polarization controller automate the sequential measurement of coherent receiver hardware performance to save you valuable test time and reduce human error for accurate and reliable results, everytime.

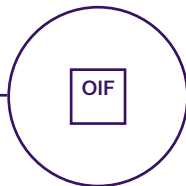

Vast coverage of key OIF test parameters.

CoRx Tester measures and reports a broad range of OIF test parameters, with plans of continuous expansion of the measurement parameters via software upgrade and hardware add-ons.



Intuitive dedicated software.

CoRx Tester comes with a dedicated software equipped with automatic device discovery to simplify the test set up procedure. The software gives access to all the measurement parameters and graphs, giving you full insight into your device's performance.



Built-in controller for remote communication.

The PXI system has a built-in PC controller module which provides fast and flexible access to each internal components to enable easy remote communication and automation.

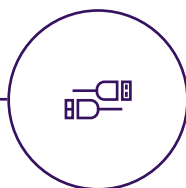

CohesionUI for individual PXIe instrument control.

The individual PXIe optical modules can be controlled from the CohesionUI web-based software. This interface can be accessed from any device on the same network with a web browser.

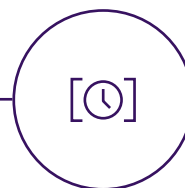

Futureproof.

The PXI platform enables you to use the test platform for a multitude of other test configurations. Choose from a wide range of Quantifi Photonics optical test modules including lasers, VOAs, switches, power meters, polarization controllers and more.

The user-friendly CoRx Tester software lets you set up and perform automated sequential tests at the press of a button.

With various visualizations to display the measured characteristics of the hardware, you can quickly generate a comprehensive characterization of your device.

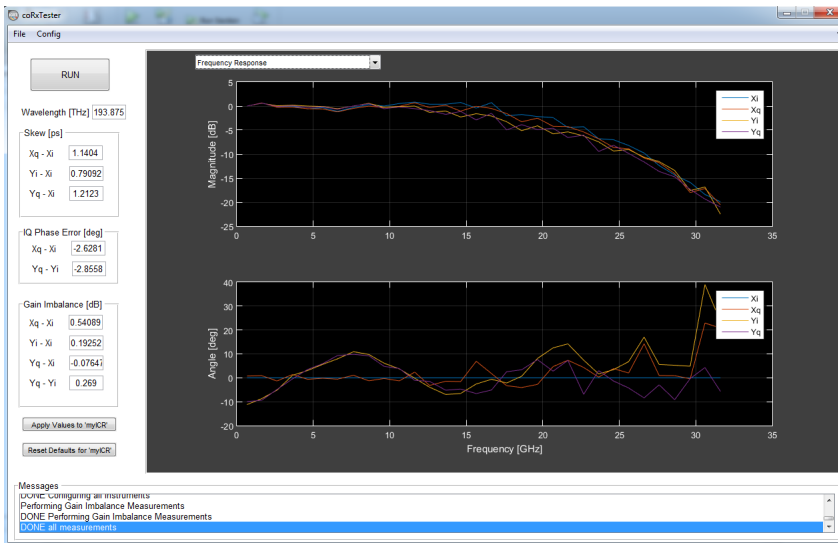

ICR TESTING SCHEMATIC DIAGRAM

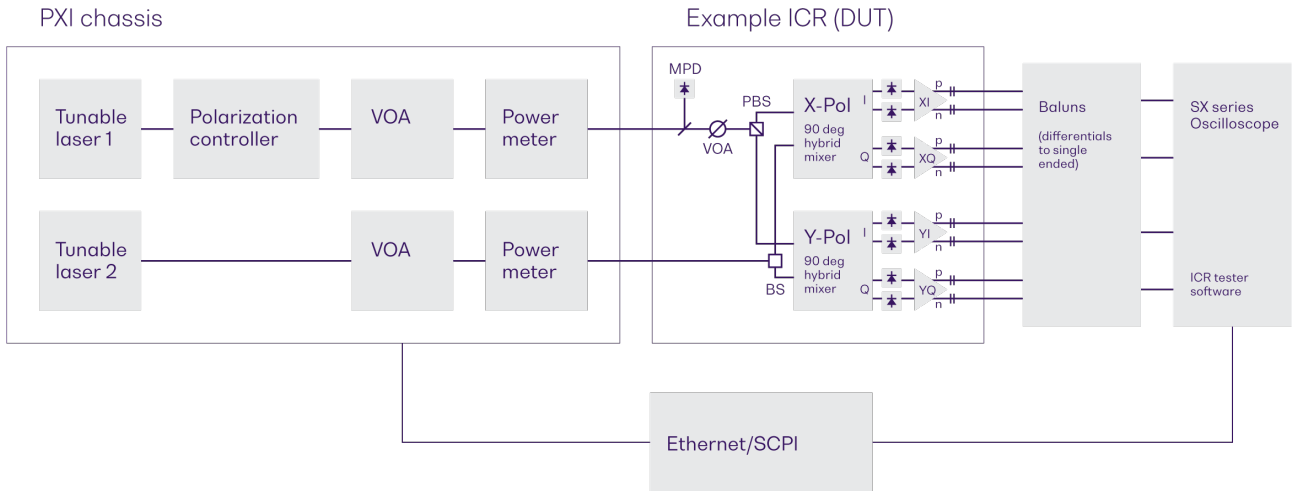

HARDWARE



CoRx Tester-1001 in a NI-1078 PXIe chassis

TECHNICAL SPECIFICATIONS

| Coherent receiver tester | CORX TESTER |
|-----------------------------|--------------------------------------------------------------------------|
| Wavelength support | C or L band |
| Composition | LASER-1052-2-PXIE POL-1001-1-PXIE VOA-1301-2-PXIE |
| ICR DUT requirements | If with differential outputs, 4 baluns are required |
| PXI dimensions | PXIe - 1078 Chassis: 355.6 x 177 x 214.2 mm 14 x 6.97 x 8.43 in |
| PC interface method | Ethernet, built-in Windows PC |
| Power supply | ~100 to 240 V; 50/60 Hz; 500 W |
| Operating temperature range | 5°C to 45°C 41°F to 113°F |
| Storage temperature range | 40°C to 70°C -40°F to 158°F |

| OIF-DPC-RX-01.2 | CORX TESTER |
|------------------------------------|-------------|
| Channel skew | Yes |
| Channel skew variation | Yes |
| p,n skew | Yes |
| Gain control accuracy | Yes |
| IQphase error | Yes |
| Total harmonic distortion | Yes |
| Image suppression versus frequency | Yes |
| Magnitude frequency response | Yes |
| Signal bandwidth 3 dB | Yes |
| Low frequency cutoff | Yes |

| Additional measurements | CORX TESTER |
|-----------------------------------|-------------|
| EVM versus frequency | Yes |
| Gain imbalances | Yes |
| Phase difference versus frequency | Yes |

ORDERING INFORMATION

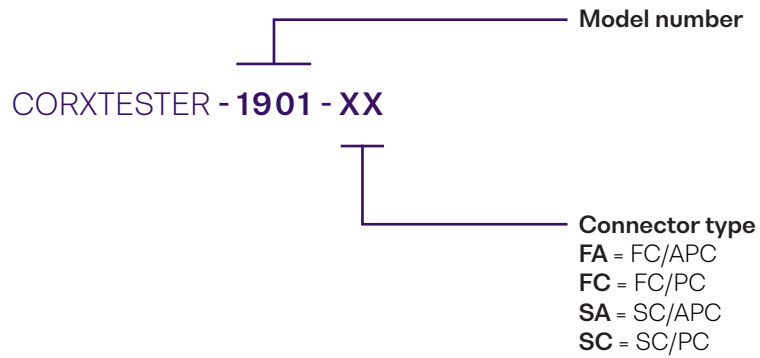

WARRANTY + CALIBRATION

This product comes with a standard 1 year warranty.

EXTENDED WARRANTIES AND CALIBRATION PLANS

With an Extended Warranty and Calibration Plan you can spend more time focused on your priorities and less time worrying about maintenance.

Over time and with regular use, all optical parts and connectors require re-calibration and maintenance to guarantee accurate and reliable performance.

You can add a 3 or 5 year Extended Warranty at the time of purchase.

Guarantee peak performance

Ensure your equipment is operating at its best for reliable and accurate results.

Lower cost of ownership

Lock in savings and maximise your budget with a lower cost of ownership.

Peace of mind

Spend less time worrying about maintenance and more on generating results.

CALIBRATION PLANS FOR ADDITIONAL DISCOUNTS

Order a Calibration Plan when you purchase your Quantifi Photonics' test instruments and qualify for additional discounts.

10% Discount

On calibrations ordered at the time of purchase.

25% Discount

Add on an extended warranty and receive a 25% discount on calibrations.

With an instrument calibration performed by Quantifi Photonics technicians you receive.

- Comprehensive calibration to factory specifications
- End-to-end inspection to ensure all instrument functions are working and connectors are clean
- Firmware, software and documentation updates
- Certificate of Calibration which includes detailed test results

We recommend Quantifi Photonics optical instruments are re-calibrated every 12 months

How to purchase

Contact your Quantifi Photonics sales representative about our Extended Warranty or Calibration Plans today or email sales@quantifiphotonics.com.

Extended Warranties and Calibration Plans must be ordered at the time of purchase and are available only for Quantifi Photonics' products. The 25% calibration discount only applies to calibrations while the product is covered by the Extended Warranty period.

Test. Measure. Solve.

Quantifi Photonics is transforming the world of photonics test and measurement. Our portfolio of optical and electrical test instruments is rapidly expanding to meet the needs of engineers and scientists around the globe. From enabling ground-breaking experiments to driving highly efficient production testing, you'll find us working with customers to solve complex problems with optimal solutions.

To find out more, get in touch with us today.

| | |
|--------------------------|-------------------------------|
| General Enquiries | sales@quantifiphotonics.com |
| Technical Support | support@quantifiphotonics.com |
| Phone | +64 9 478 4849 |
| North America | +1-800-803-8872 |



[quantifiphotonics.com](https://www.quantifiphotonics.com)

**QUANTIFI
PHOTONICS™**