

Radar Target Simulator, Direct Reading, 71 to 76 GHz

Description:

Model STR-743-12-D1 is a radar doppler simulator that operates at 73.5 GHz with a bandwidth of ± 2.5 GHz and a WR-12 waveguide input/output. The simulator utilizes a single-sideband-modulator to modulate the incoming signal transmitted by the radar under test and sends back either a higher or lower band signal through a diplexer. The frequency-shifted signal is transmitted back to the radar under test as a Doppler signal. Target characteristics are adjusted by changing the I and Q channel frequency and phase. The routing attenuation is adjusted by the direct reading attenuator.



Features:

- Single Sideband Output
- Simulated Target Speed and Size Adjustable
- Simulated Target Moving Direction Switchable
- Instrumentation Grade

Applications:

- Doppler Target Simulations
- Radar System Testing

Electrical Specifications:

Parameter	Minimum	Typical	Maximum
Center Frequency		73.5 GHz	
RF Bandwidth		± 2.5 GHz	
Carrier Rejection		30 dB	
Image Rejection		20 dB	
Routing Loss Range		25 to 125 dB	
I/Q Frequency Range	DC		250 MHz
I/Q Voltage		± 10 V _{p-p}	± 12 V _{p-p}
I/Q Current		± 2.5 mA	± 5 mA
I/Q Phase Error		$\pm 5^\circ$	
Specification Temperature		+25 °C	
Operating Temperature	0 °C		+50 °C

Mechanical Specifications:

Item	Specification
RF Port	WR-12 Waveguide with UG-387/U Flange
I/Q Ports	SMA(F)
Size	6.91" (W) x 11.03" (L) x 5.10" (H)
Case Finish	Black Anodized
Outline	TR-ED



Radar Target Simulator, Direct Reading, 71 to 76 GHz

Mechanical Outline: (Unless otherwise specified, all dimensions are in inches[millimeters])

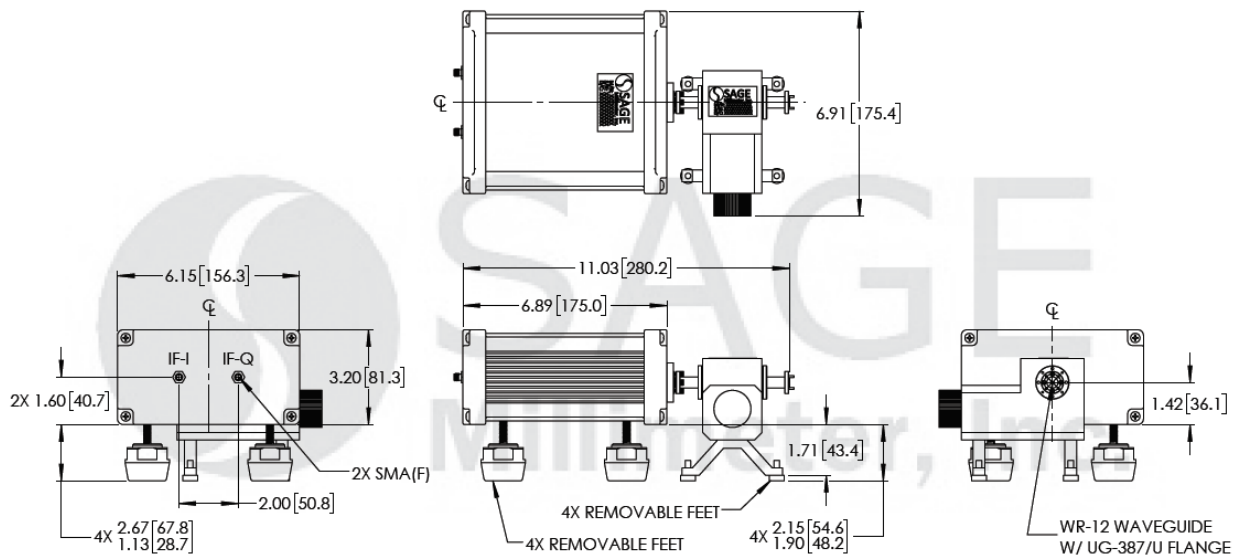
**Note:**

- Eravant reserves the right to change the information presented without notice.
- Models with different operation frequencies are available under a different model numbers.
- A 73.5 GHz Radar Target Simulator with a **level setting attenuator**, instead of a direct reading attenuator, is available as model **STR-743-12-L1**.

Caution:

- Exceeding absolute maximum ratings of the device will damage the device.
- Proper torque, 8.0 ± 0.15 inch-pounds (0.92 ± 0.05 Nm), should be applied. **Eravant torque wrench, model SCH-08008-S1, is highly recommended.**
- Any foreign objects in the waveguide will cause performance degradation and may damage the device.

