



SHF Communication Technologies AG

Wilhelm-von-Siemens-Str. 23D • 12277 Berlin • Germany

Phone +49 30 772 051-0 • Fax +49 30 753 10 78

E-Mail: sales@shf.de • Web: <http://www.shf.de>

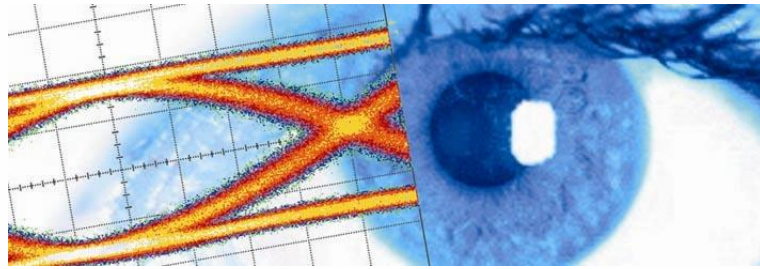

Datasheet

SHF EQ25 A

Broadband Linear Equalization Filter

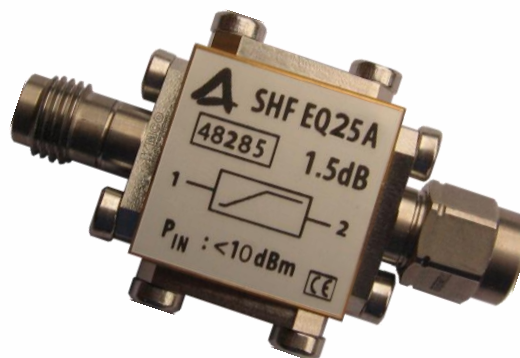



Description

The SHF EQ25 A is a RoHS compliant passive broadband linear equalizing filter with a small form factor. It is designed to compensate for linearly increasing insertion loss in the signal transmission path. The Nyquist frequency of the filter has been chosen to be around 25 GHz, covering signal baud rate in the region of 50 to 56 Gbaud. Typical applications include compensation for distortions due to the loss of bandwidth of a DUT, and additional insertion loss due to the inclusion of RF cable(s) in the signal path.

This filter is suitable for both NRZ and PAM4 data formats in the region of 50 to 56 Gbaud.

The filter has a DC coupled transmission path. So it can transfer a DC voltage for the DUT. The compensation path to GND is AC coupled. Due to this fact, the compensation operates down to ~ 50 kHz, capable of handling data sequence length of up to $2^{31}-1$ PRBS.

Available Configurations

- 1.5 dB¹
- 3 dB¹

Specifications - SHF EQ25 A

Parameter	Unit	Symbol	Min	Typ	Max	Conditions
Absolute Maximum Ratings						
Maximum RF Input	dBm V	$P_{in\ max}$			10 2	peak to peak voltage
DC Voltage at RF Input	V				±12	
DC Voltage at RF Output	V				±12	
DC Current	A				0.5	
Case Temperature	T_{case}	°C	10	25	60	
Mechanical Characteristics						
Input Connector						1.85mm (V) female ²
Output Connector						1.85mm (V) male ²

¹ Defined as the filter peaking value from low to the Nyquist frequency of 25 GHz.

² Other gender configurations are available on request.



Specifications - SHF EQ25 A Option 1.5 dB

Parameter	Unit	Symbol	Min	Typ	Max	Conditions
Electrical Characteristics (At 25°C case temperature, unless otherwise specified)						
Insertion Loss	dB	S ₂₁ LOW	2.4		2.8	at 1 GHz
Insertion Loss	dB	S ₂₁ PEAK	0.8		1.4	at 25 GHz
Insertion Loss	dB	S ₂₁ HIGH	0.5		2.5	25 ... 40 GHz
Input Reflection	dB	S ₁₁			-9 -10	40 MHz ... 25 GHz 25 GHz ... 40 GHz
Output Reflection	dB	S ₂₂			-9 -10	40 MHz ... 25 GHz 25 GHz ... 40 GHz

Specifications - SHF EQ25 A Option 3 dB

Parameter	Unit	Symbol	Min	Typ	Max	Conditions
Electrical Characteristics (At 25°C case temperature, unless otherwise specified)						
Insertion Loss	dB	S ₂₁ LOW	3.8		4.2	at 1 GHz
Insertion Loss	dB	S ₂₁ PEAK	0.8		1.4	at 25 GHz
Insertion Loss	dB	S ₂₁ HIGH	0.5		2.5	25 ... 40 GHz
Input Reflection	dB	S ₁₁			-7 -10	40 MHz ... 25 GHz 25 GHz ... 40 GHz
Output Reflection	dB	S ₂₂			-7 -9	40 MHz ... 25 GHz 25 GHz ... 40 GHz



Typical S-Parameters and Phase Response

blue: EQ25 A-1.5 dB
red: EQ25 A-3 dB

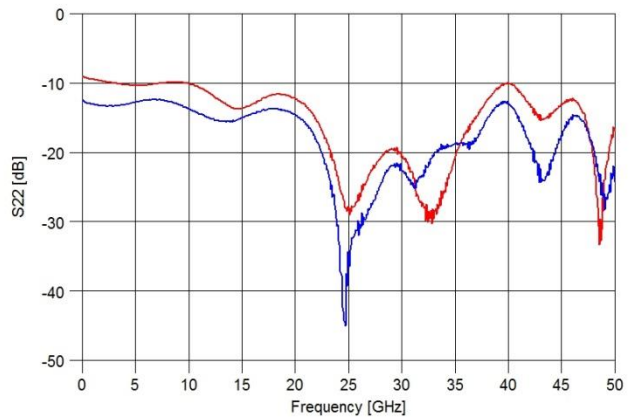
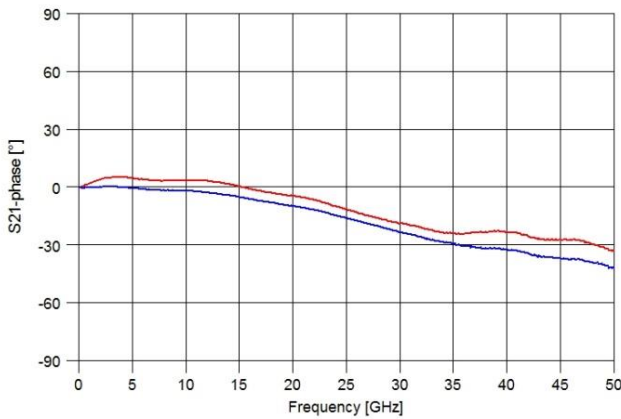
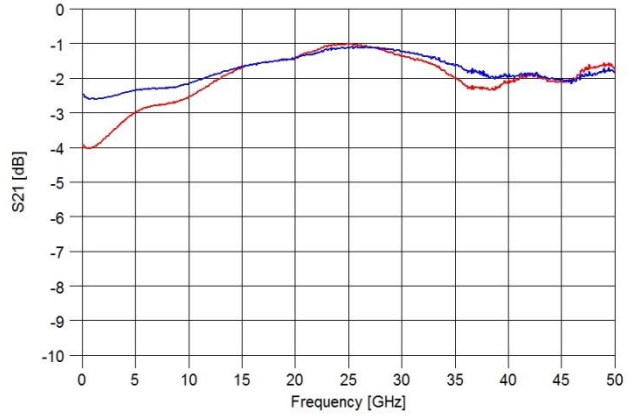
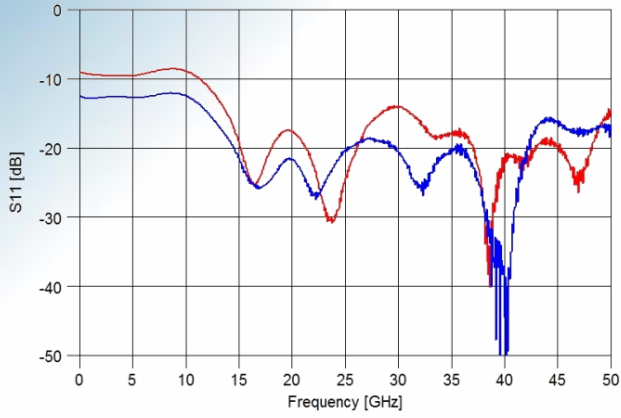

Low Frequency Response < 100 kHz

(no DC on Input)

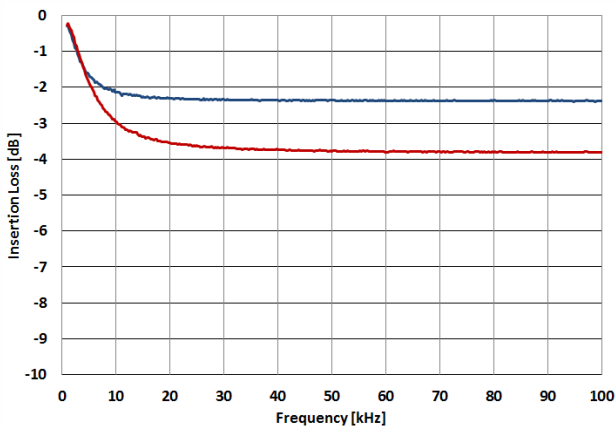



Binary Eye Diagrams with EQ25 A-1.5 dB

Example to show compensation for ~ 1.5 dB transmission loss at Nyquist frequency. DUT is 0.5 m Totoku TCF280QR with typical insertion loss of 1.5 dB at 25 GHz.

All measurements had been performed using a SHF613 A DAC in binary mode and an Agilent 86100C DCA with Precision Time Base Module (86107A) and 70 GHz Sampling Head (86118A).

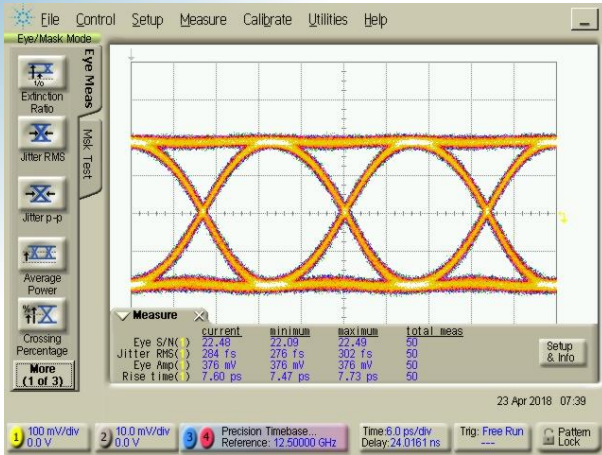

50 Gbps without cable

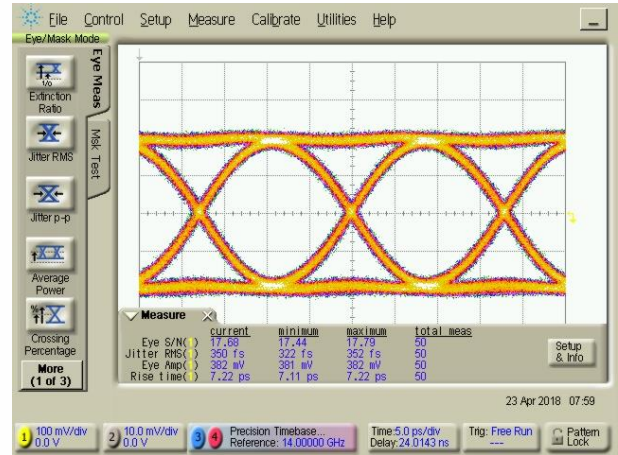

56 Gbps without cable

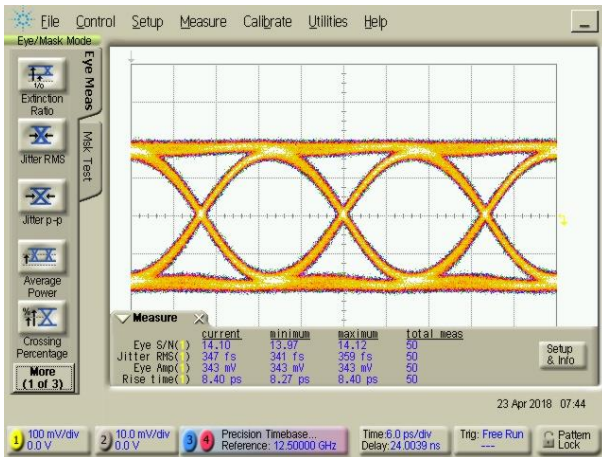

50 Gbps with 0.5 m TCF280QR

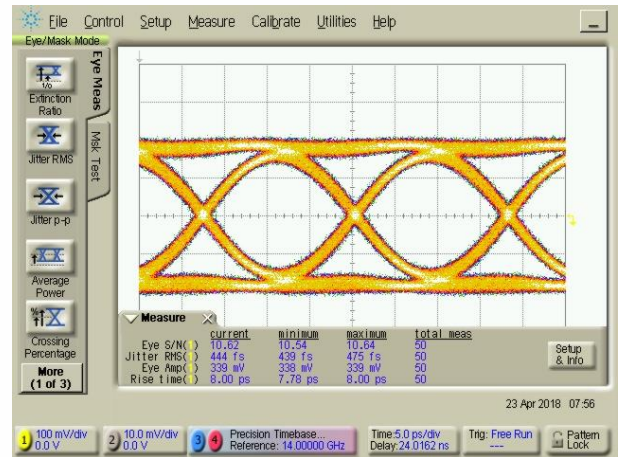

56 Gbps with 0.5 m TCF280QR

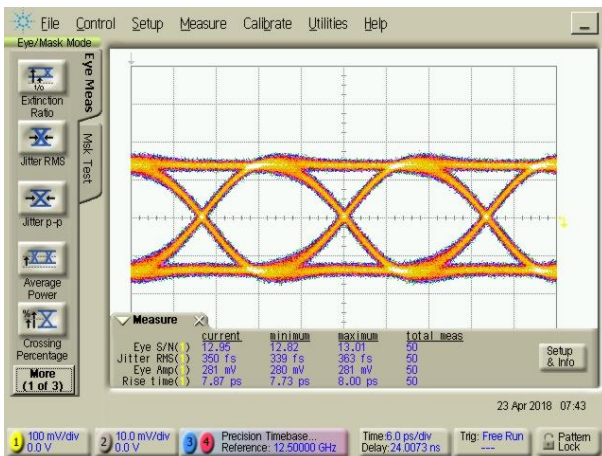

50 Gbps with 0.5 m TCF280QR and EQ25 A-1.5 dB

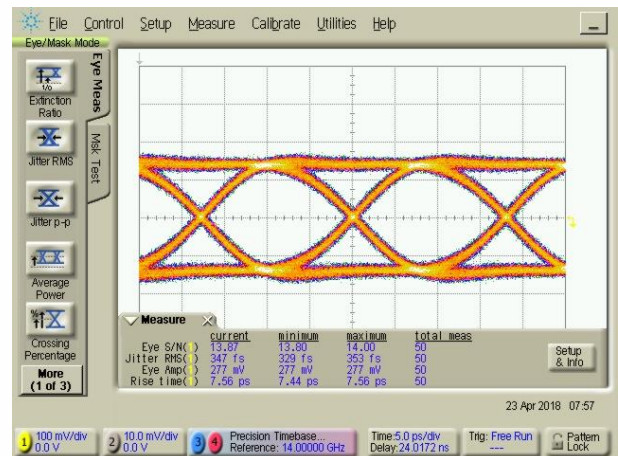

56 Gbps with 0.5 m TCF280QR and EQ25 A-1.5 dB



4-Level Eye Diagrams with EQ25 A-1.5 dB

All measurements had been performed using a SHF613 A DAC and an Agilent 86100C DCA with Precision Time Base Module (86107A) and 70 GHz Sampling Head (86118A).

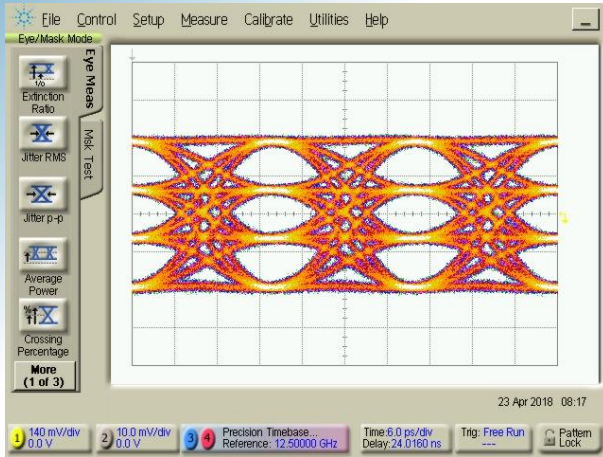

50 GBaud without cable

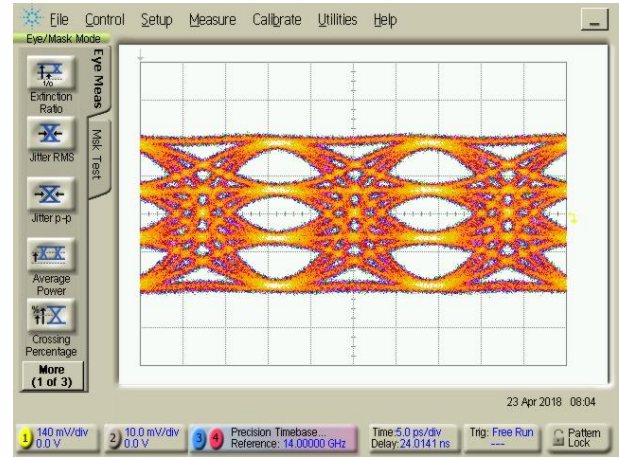

56 GBaud without cable

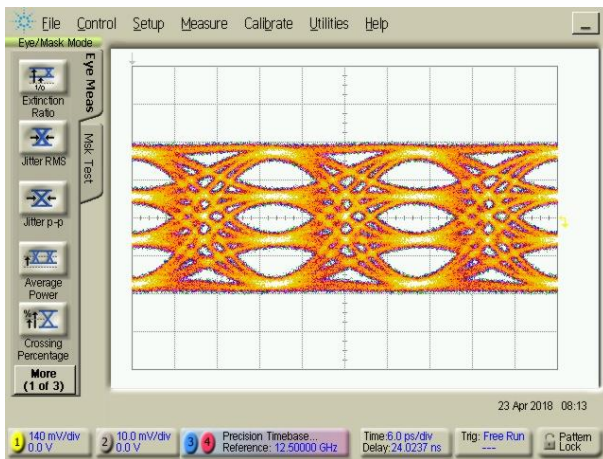

50 GBaud with 0.5 m Totoku TCF280QR

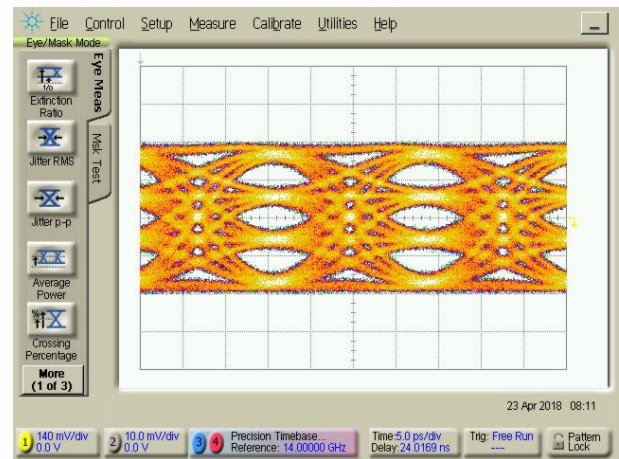

56 GBaud with 0.5 m Totoku TCF280QR

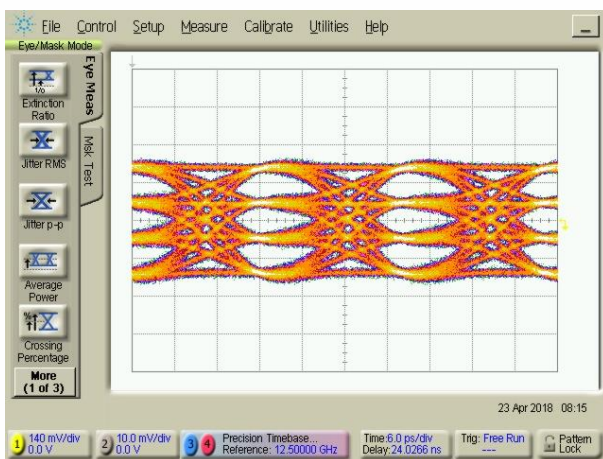

50 GBaud with 0.5 m TCF280QR and EQ25 A-1.5 dB

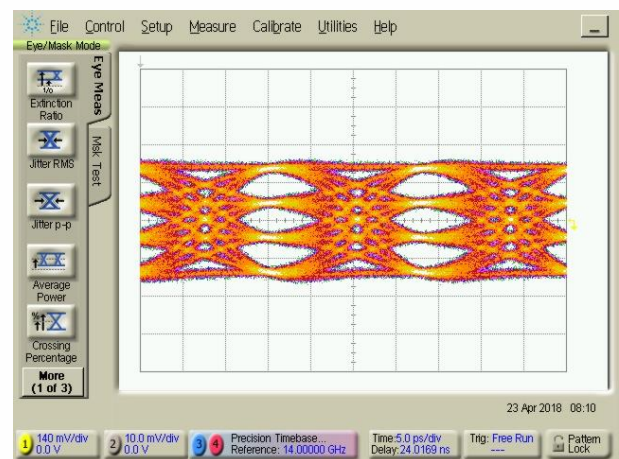

56 GBaud with 0.5 m TCF280QR and EQ25 A-1.5 dB



Binary Eye Diagrams with EQ25 A-3 dB

Example to show compensation for ~ 3 dB transmission loss at Nyquist frequency. DUT is 1 m Totoku TCF280QR with typical insertion loss of 3 dB at 25 GHz.

All measurements had been performed using a SHF613 A DAC in binary mode and an Agilent 86100C DCA with Precision Time Base Module (86107A) and 70 GHz Sampling Head (86118A).

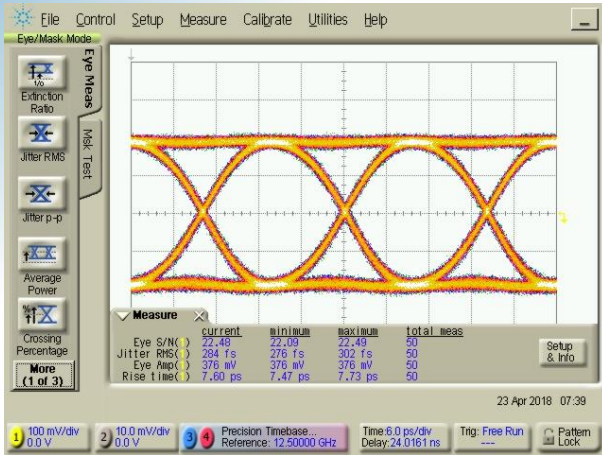

50 Gbps without cable

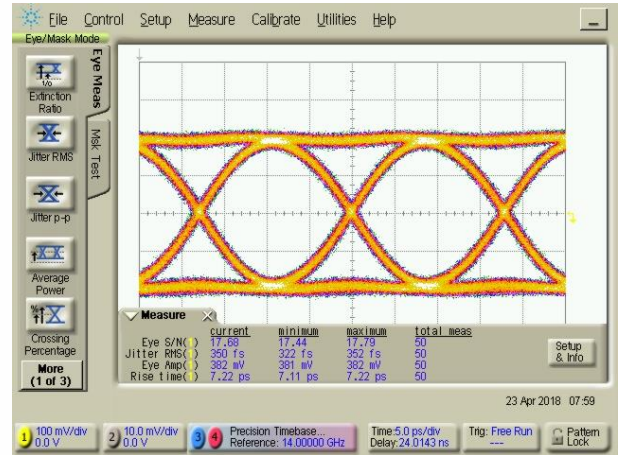

56 Gbps without cable

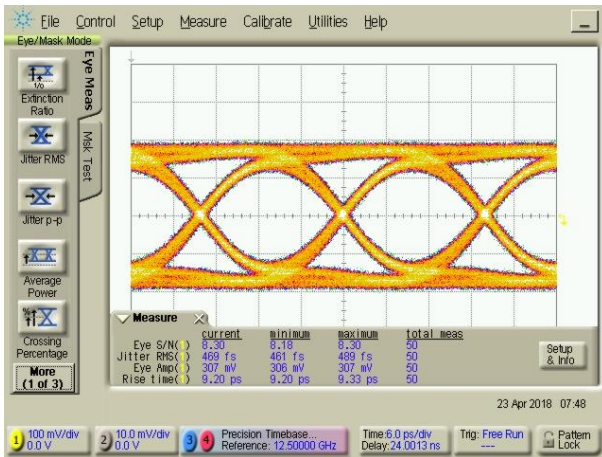

50 Gbps with 1 m TCF280QR

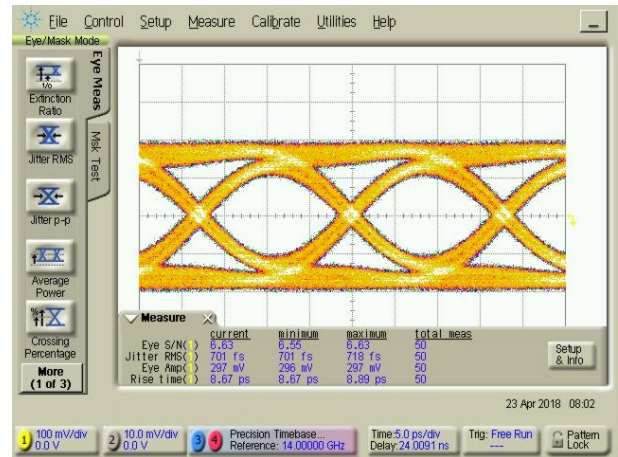

56 Gbps with 1 m TCF280QR

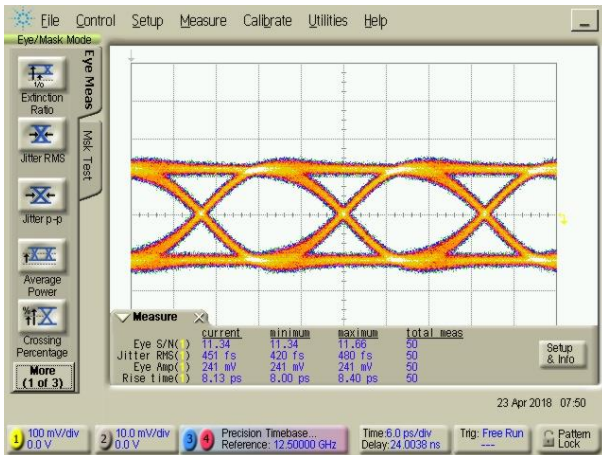

50 Gbps with 1 m TCF280QR and EQ25 A-3 dB

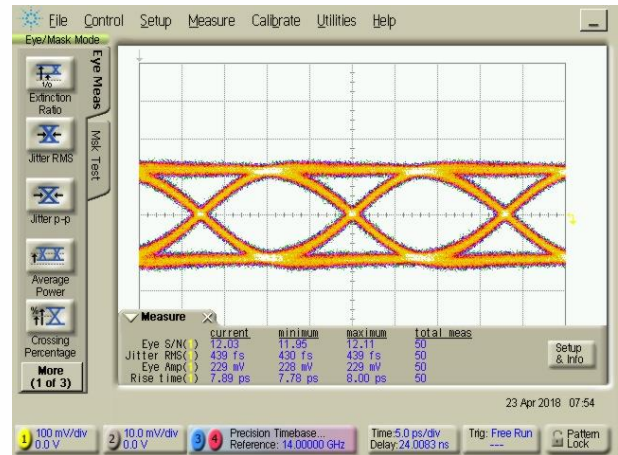

56 Gbps with 1 m TCF280QR and EQ25 A-3 dB



4-Level Eye Diagrams with EQ25 A-3 dB

All measurements had been performed using a SHF613 A DAC and an Agilent 86100C DCA with Precision Time Base Module (86107A) and 70 GHz Sampling Head (86118A).

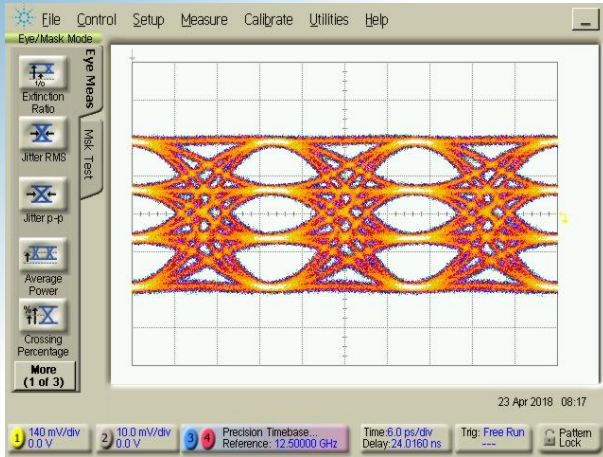

50 GBaud without cable

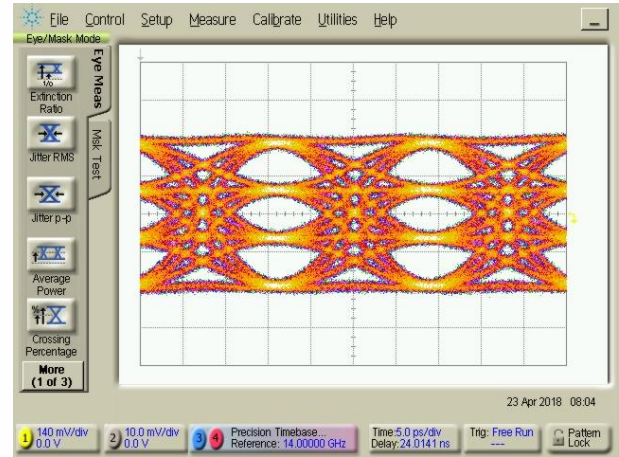

56 GBaud without cable

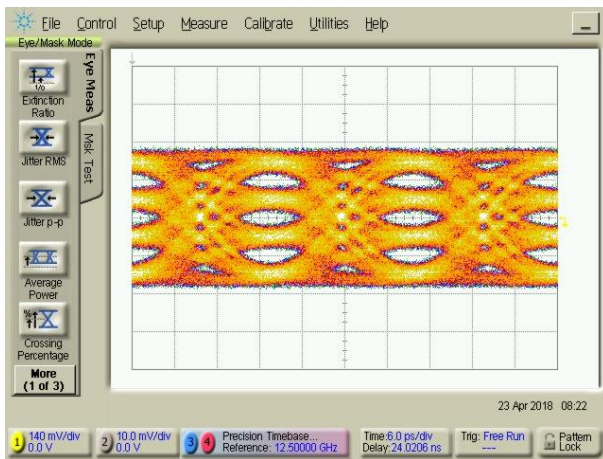

50 GBaud with 1 m Totoku TCF280QR

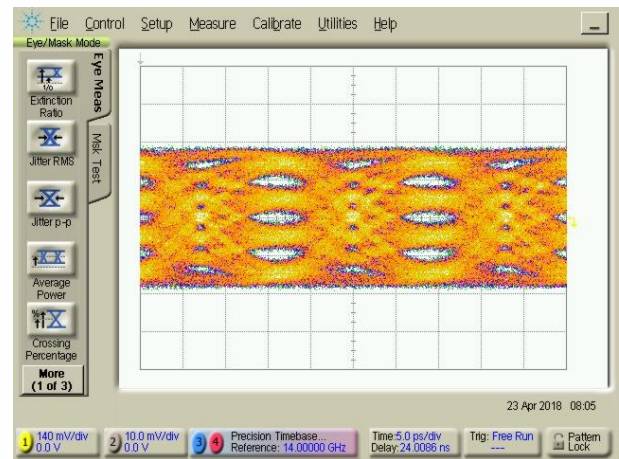

56 GBaud with 1 m Totoku TCF280QR

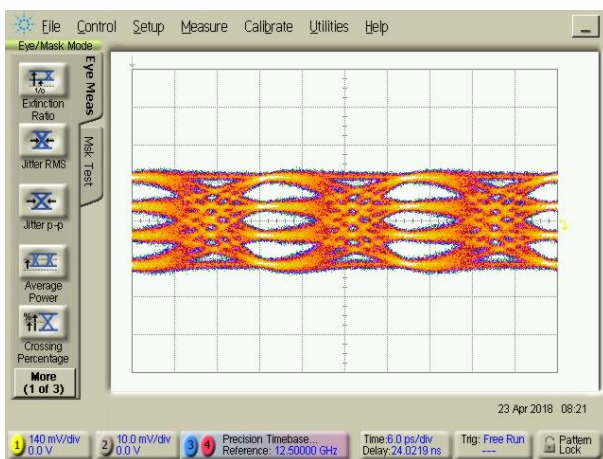

50 GBaud with 1 m TCF280QR and EQ25 A-3 dB

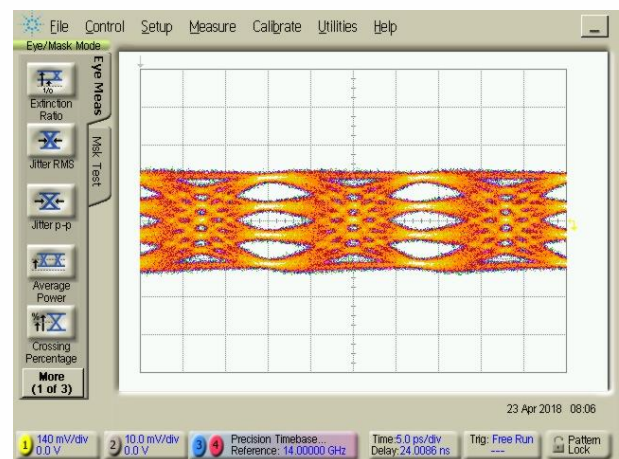

56 GBaud with 1 m TCF280QR and EQ25 A-3 dB



Frequency Response of 0.5 m cable and EQ25 A-1.5 dB

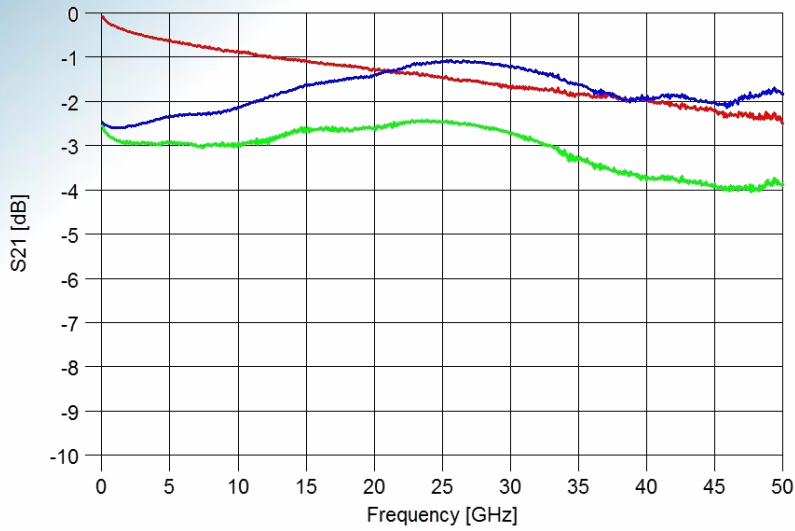

blue: EQ25 A-1.5 dB
red: 0.5 m cable
green: 0.5 m cable and EQ25 A-1.5 dB

Frequency Response of 1 m cable and EQ25 A-3 dB

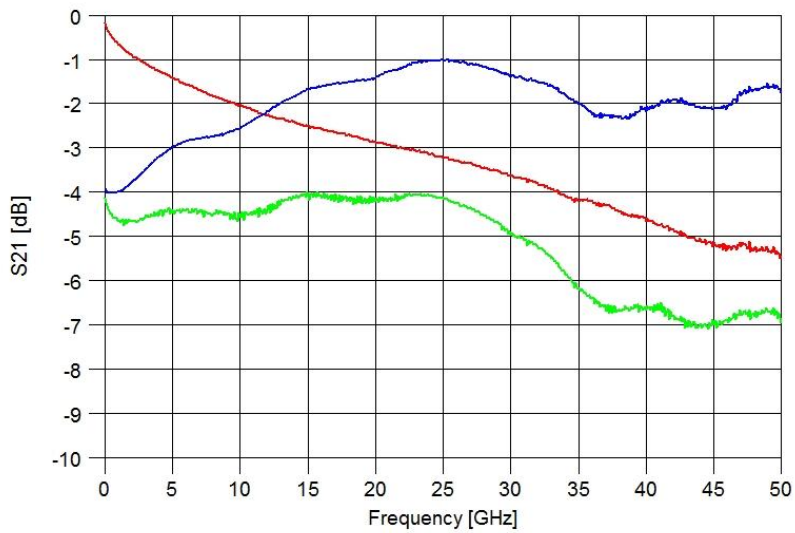

blue: EQ25 A-3 dB
red: 1 m cable
green: 1 m cable and EQ25 A-3 dB



Mechanical Drawing

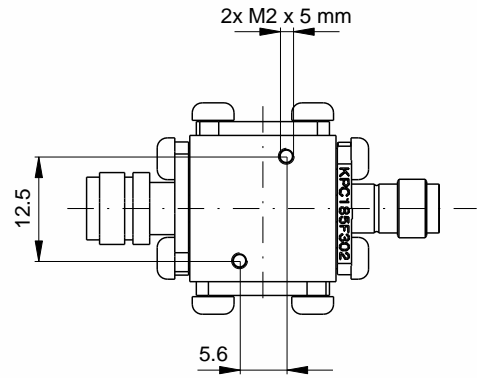
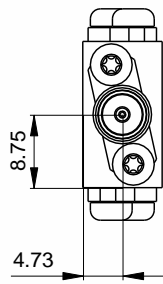
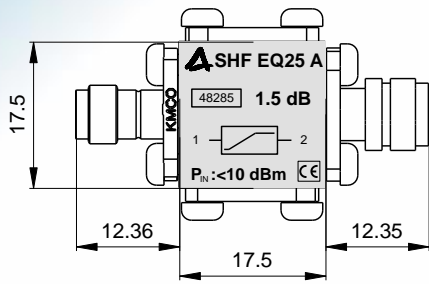
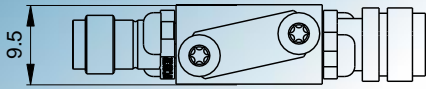

all dimensions in mm

Input connector: 1.85mm (V) female
Output connector: 1.85mm (V) male